

INSTALLATION GUIDE FOR

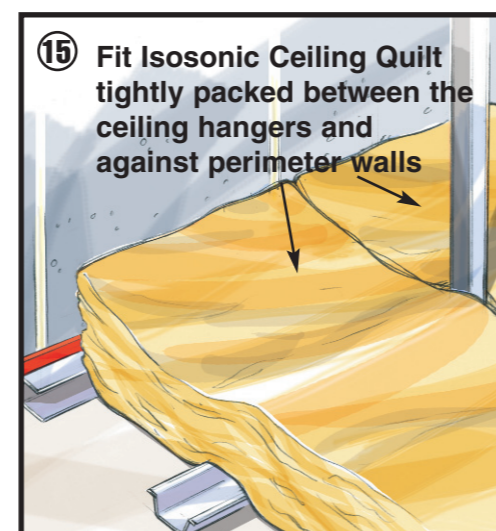

ROBUST DETAILS Registration Compliance requires the site supervisory personnel and the screeding team to undertake on-site installation training. Contact Thermal Economics on 01582 544237 to arrange your training.

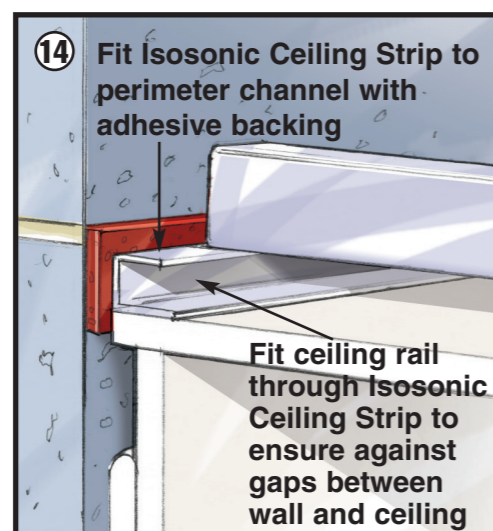
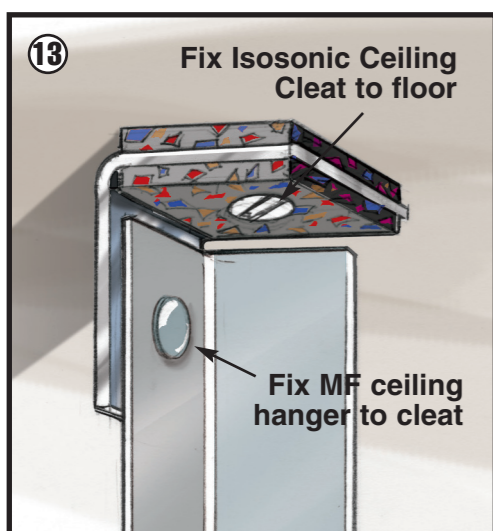
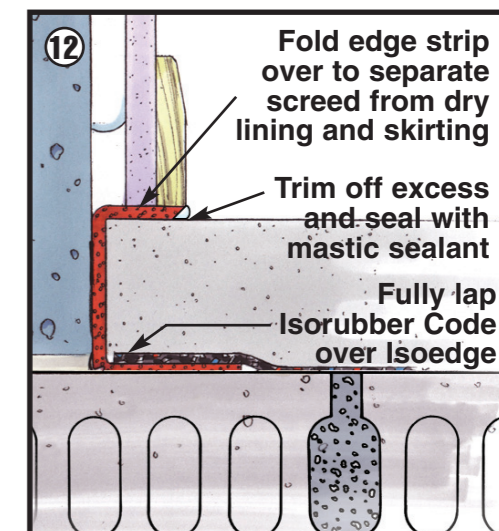
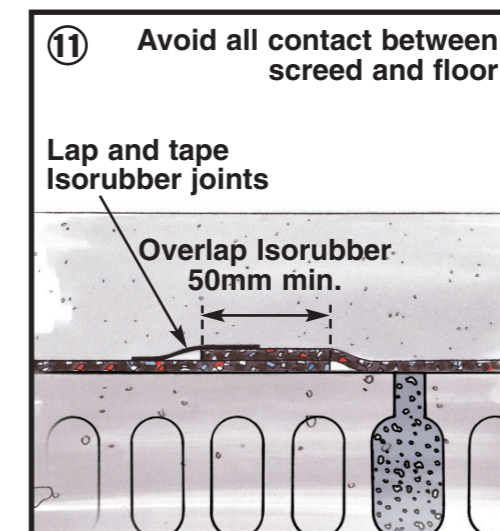
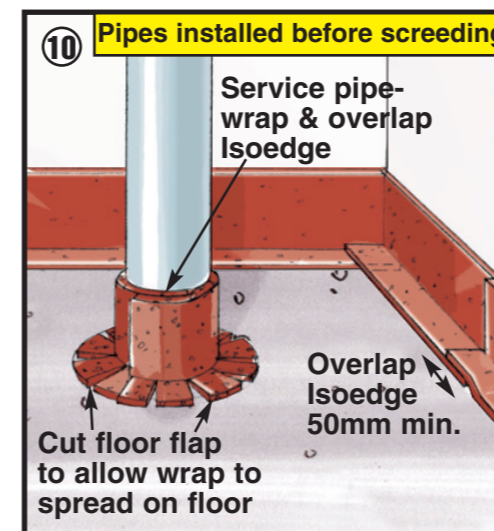
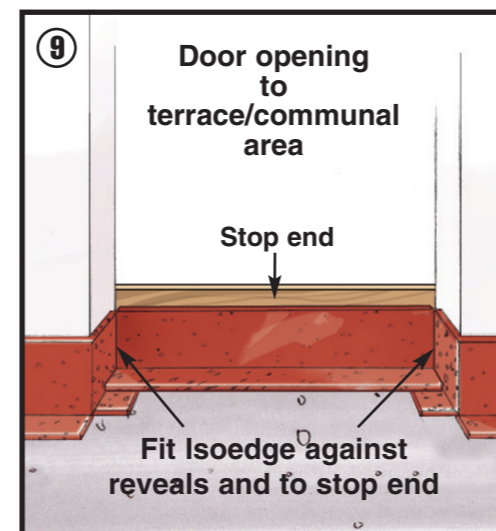
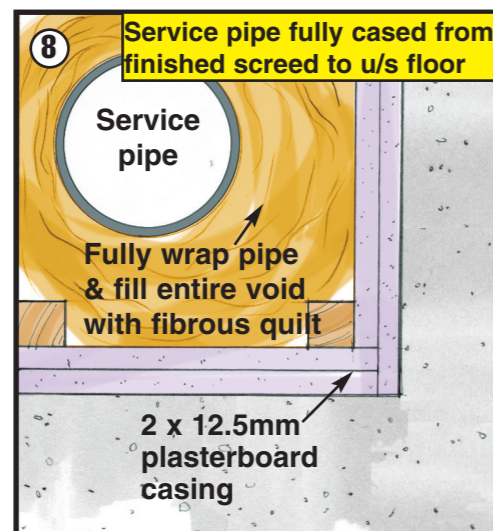
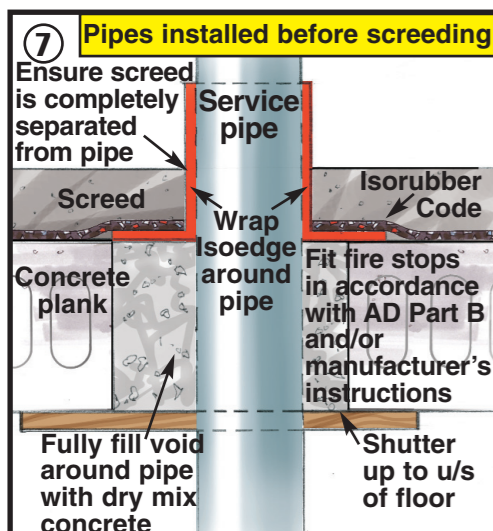
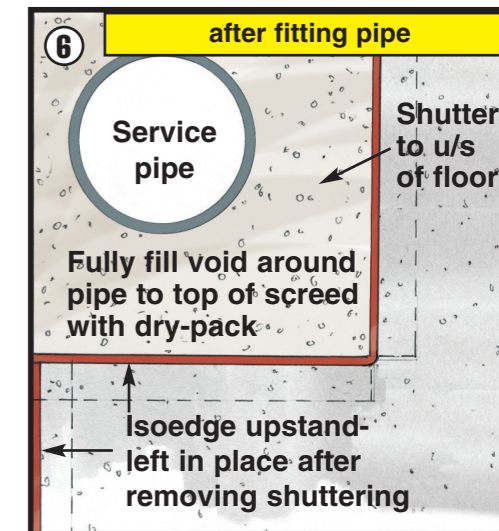
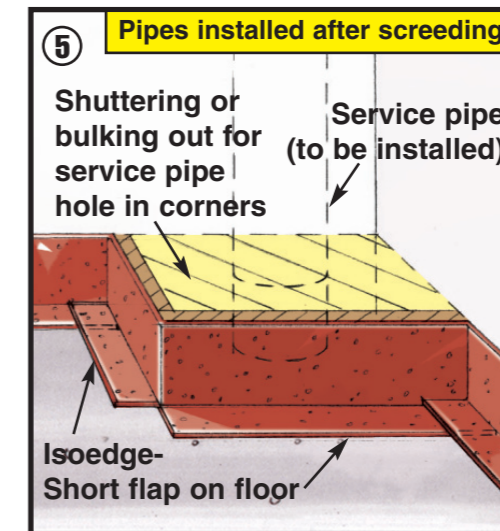
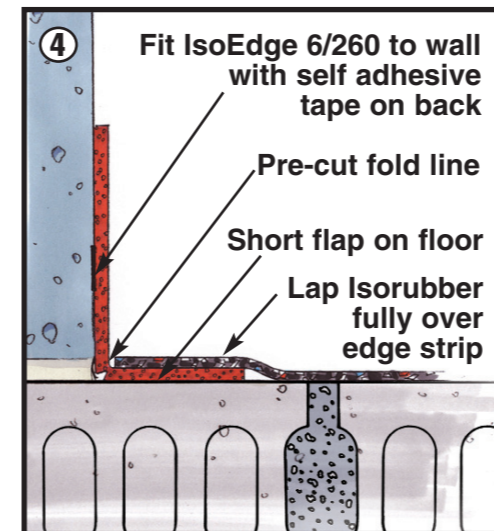
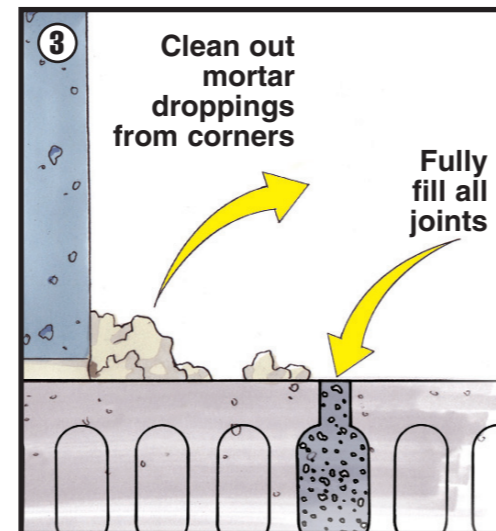
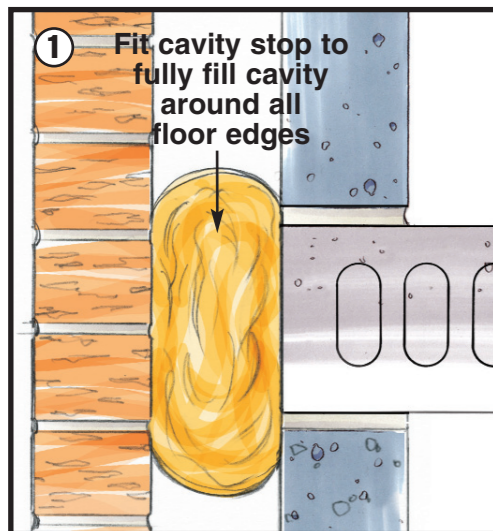

IMPORTANT!!!

E-FC-14 is currently the only ROBUST DETAIL that can automatically provide 3 CODE FOR SUSTAINABLE HOMES CREDITS. This requires an exceptionally high acoustic insulation performance for which it is essential that all the above guidance is adhered to and applied with the highest possible standard of workmanship.

Thermal Economics
THERMAL & SOUND INSULATION TECHNOLOGY

FOR FURTHER INFORMATION CONTACT THERMAL ECONOMICS TECHNICAL DEPARTMENT ON 01582 544255